

SANYO

VCB-9124

INSTRUCTION MANUAL

B/W CCD CAMERA

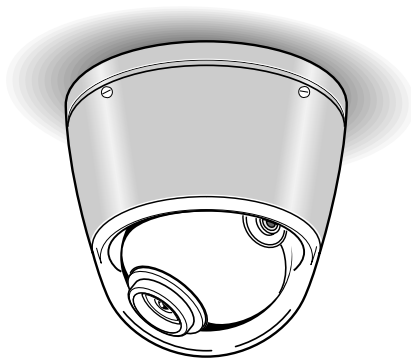

About this manual

Before installing and using the camera, please read this manual carefully. Be sure to keep it handy for later reference.

SANYO INDUSTRIAL VIDEO B/W VIDEO CAMERA LIMITED WARRANTY

OBLIGATIONS

In order to obtain warranty service, the product must be delivered to and picked up from an Authorized Sanyo Service Center at the user's expense, unless specifically stated otherwise in this warranty. The names and addresses of Authorized Sanyo Service Centers may be obtained by writing to SFS Corporation, SFC's warranty administrator, at any of the addresses listed below, or by calling (toll-free) 1-800-421-5013.

New Jersey Office
210 Riser Road
Little Ferry, NJ 07643
201-641-3000

California Office
1200 W. Artesia Blvd.
Compton, CA 90220
310-537-5830

Illinois Office
900 N. Arlington Heights Rd.
Itasca, IL 60143
708-775-1414

THIS WARRANTY IS VALID ONLY ON SANYO PRODUCTS PURCHASED OR RENTED IN THE UNITED STATES OF AMERICA, EXCLUDING HAWAII AND ALL U.S. TERRITORIES AND PROTECTORATES. THIS WARRANTY APPLIES ONLY TO THE ORIGINAL RETAIL USER. THE ORIGINAL DATED BILL OF SALE, SALES SLIP OR RENTAL AGREEMENT MUST BE SUBMITTED TO THE AUTHORIZED SANYO SERVICE CENTER AT THE TIME WARRANTY SERVICE IS REQUESTED.

Subject to the OBLIGATIONS above and EXCLUSIONS below, SANYO FISHER (USA) CORPORATION warrants this SANYO product against defects in materials and workmanship for the periods specified below. SFC will repair or replace (at its option) the product and any of its parts which fail to conform to this warranty. The warranty period commences on the date the product was first purchased or rented at retail.

LABOR	PARTS	IMAGE DEVICE
2 YEARS	2 YEARS	5 YEARS

EXCLUSIONS

This warranty does not cover (A) the adjustment of customer-operated controls as explained in the appropriate model's instruction manual, or (B) the repair of any product whose serial number has been altered, defaced or removed.

This warranty shall not apply to the cabinet or cosmetic parts, antenna, knobs, batteries or image burns to projection or picture tubes caused by electronic devices or games.

This warranty does not apply to uncrating, setup, installation, removal of the product for repair or reinstallation of the product after repair.

This warranty does not apply to repairs or replacements necessitated by any cause beyond the control of SFC including, but not limited to, any malfunction, defect or failure caused by or resulting from unauthorized service or parts, improper maintenance, operation contrary to furnished instructions, shipping or transit accidents, modification or repair by the user, abuse, misuse, neglect, accident, incorrect power line voltage, fire, flood or other Acts of God, or normal wear and tear.

The foregoing is in lieu of all other expressed warranties and SFC does not assume or authorize any party to assume for it any other obligation or liability.

THE DURATION OF ANY WARRANTIES WHICH MAY BE IMPLIED BY LAW (INCLUDING THE WARRANTIES OF MERCHANTABILITY AND FITNESS) IS LIMITED TO THE TERM OF THIS WARRANTY. IN NO EVENT SHALL SFC BE LIABLE FOR SPECIAL, INCIDENTAL OR CONSEQUENTIAL DAMAGES ARISING FROM OWNERSHIP OR USE OF THIS PRODUCT, OR FOR ANY DELAY IN THE PERFORMANCE OF ITS OBLIGATIONS UNDER THIS WARRANTY DUE TO CAUSES BEYOND ITS CONTROL.

SOME STATES DO NOT ALLOW LIMITATIONS ON HOW LONG AN IMPLIED WARRANTY LASTS AND/OR DO NOT ALLOW THE EXCLUSION OR LIMITATION OF CONSEQUENTIAL DAMAGES, SO THE ABOVE LIMITATIONS AND EXCLUSIONS MAY NOT APPLY TO YOU.

THIS WARRANTY GIVES YOU SPECIFIC LEGAL RIGHTS. YOU MAY HAVE OTHER RIGHTS, WHICH VARY FROM STATE TO STATE.

ATTENTION

For your protection in the event of theft or loss of this product, please fill in the information below for your own personal records.

Model No. _____

Serial No. _____
(Located on back or bottom side of unit.)

Date of Purchase _____

Purchase Price _____

Where Purchased _____

INFORMATION TO USER

Safety Guard



THIS SYMBOL INDICATES THAT THERE ARE IMPORTANT OPERATING AND MAINTENANCE INSTRUCTIONS IN THE LITERATURE ACCOMPANYING THIS UNIT.

WARNING:

TO PREVENT THE RISK OF FIRE OR ELECTRIC SHOCK , DO NOT EXPOSE THIS APPLIANCE TO RAIN OR MOISTURE.

For the customers in Canada

This Class B digital apparatus complies with Canadian ICES-003.

Pour la clientèle canadienne

Cet appareil numérique de la Classe B est conforme à la norme NMB-003 du Canada.

This installation should be made by a qualified service person and should conform to all local codes.

This equipment has been tested and found to comply with the limits for a Class B digital device, pursuant to Part 15 of the FCC Rules.

These limits are designed to provide reasonable protection against harmful interference in a residential installation. This equipment generates, uses, and can radiate radio frequency energy and, if not installed and used in accordance with the instructions, may cause harmful interference to radio communications.

However, there is no guarantee that interference will not occur in a particular installation. If this equipment does cause harmful interference to radio or television reception, which can be determined by turning the equipment off and on, the user is encouraged to try to correct the interference by one or more of the following measures:

- Reorient or relocate the receiving antenna.
- Increase the separation between the equipment and receiver.
- Connect the equipment into an outlet on a circuit different from that to which the receiver is connected.
- Consult the dealer or an experienced radio/TV technician for help.

This device complies with Part 15 of the FCC Rules. Operation is subject to the following two conditions: (1) This device may not cause harmful interference, and (2) this device must accept any interference received, including interference that may cause undesired operation.

Changes or modifications not expressly approved by **Sanyo** may void the user's authority to operate this camera.

CONTENTS

PRECAUTIONS	3
PARTS NAMES AND FUNCTIONS	4
PREPARATIONS AND CONNECTIONS	7
CONNECTIONS AND INSTALLATION	8
SETTINGS AND ADJUSTMENTS	11
INFRARED (IR LED) ILLUMINATION RANGE	14
TROUBLESHOOTING	15
SPECIFICATIONS	16

Accessories

Screws for base installation
(4 x 35 tapping screws)

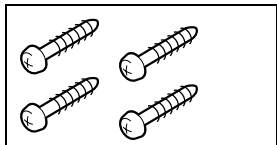

The rated value label is located on the back of the camera.

FEATURES

- Built-in interline transfer method 1/3" CCD, approx. 270,000 picture elements
- Low smear, anti-blooming, low lag, no burning and no geometric distortion using the CCD solid state image device
- Built-in Vari Focal type auto iris lens, F=2.0 - 2.7, f=2,6 - 5.6 mm
- 100% solid state components giving excellent immunity to shock and vibration
- Not subject to interference from magnetic or electrostatic fields
- Built-in IR. LED by very required minimum illumination is approx. 0 lux at 4.5 m
- Horizontal resolution, more than 400 TV lines
- With manual PAN/TILT/ROUND mechanism
- Power supply: 24 V AC operation

PRECAUTIONS

■ In case of problem

Do not use the camera if smoke or a strange odour comes from the unit, or if it seems not to function correctly. Disconnect the power cord immediately, and consult your dealer (or a Sanyo Authorized Service Centre).

■ Do not open or modify

Do not open the cabinet, as it may be dangerous and cause damage to the unit. For internal settings and repairs, consult your dealer (or a Sanyo Authorized Service Centre).

■ Do not put objects inside the unit

Make sure that no metal objects or flammable substance get inside the camera. If used with a foreign object inside, it could cause a fire, short-circuits or damages.

If water or a liquid gets inside the camera, disconnect the power cord immediately, and consult your dealer (or a Sanyo Authorized Service Centre). Be careful to protect the camera from rain, sea water, etc.

■ Be careful when handling the unit

To prevent damages, do not drop the camera or subject it to strong shock or vibration.

■ Install away from electric or magnetic fields

If installed close to a TV, radio transmitter, magnet, electric motor, transformer, audio speakers the magnetic field they generate will distort the image.

■ Protect from humidity and dust

To prevent damages to the camera, do not install it where there is greasy smoke or steam, where the dampness may get too high, or where there is a lot of dust.

■ Protect from high temperatures

Do not install close to stoves, or other heat generating devices, such as spotlights, etc., or where it could be subject to direct sunlight, as that could cause deformation, discoloration or other damages.

Be careful when installing close to the ceiling, in a kitchen or boiler room, as the temperature may raise to high levels.

Install where the temperature range will stay between -10°C and 50°C . (no condensation)

■ Cleaning

- Dirt can be removed from the cabinet by wiping it with a soft cloth. To remove stains, wipe with a soft cloth moistened with a soft detergent solution and wrung dry, then wipe dry with dry soft cloth.
- Do not use benzine, thinner or other chemical product on the cabinet, as that may cause deformation and paint peeling. Before using a chemical cloth, make sure to read all accompanying instructions. Make sure that no plastic or rubber material comes in contact with the cabinet for a long period of time, as that may cause damage or paint peeling.

PARTS NAMES AND FUNCTIONS

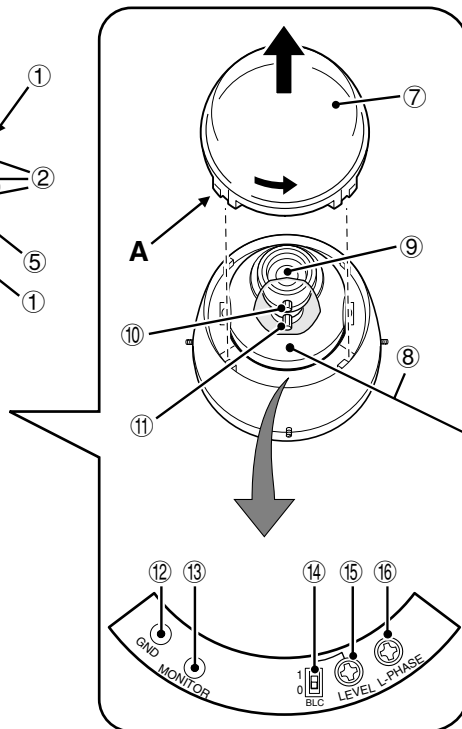
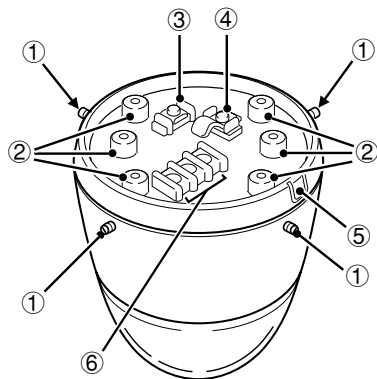

Manual pan, tilt and rotation

The angle of the lens can be adjusted manually in ranges indicated below.

- A:** Horizontally $\pm 45^\circ$
- B:** Vertically $\pm 60^\circ$
- C:** Rotation of the camera unit $\pm 35^\circ$

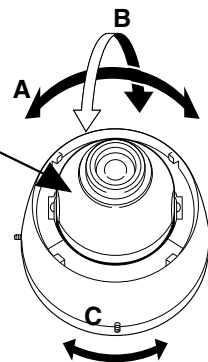

PARTS NAMES AND FUNCTIONS

① Camera unit fixing screws (4)

These screws are used to attach the camera unit to the base. Tighten the four screws evenly when attaching the camera unit.

② Screw openings for base installation

These openings are to attach the base to the ceiling or a wall using the four supplied tapping screws.

③ CAMERA (VIDEO) OUT terminal screw

Video signal output terminal. Insert the center wire of the coaxial cable into the CAMERA OUT terminal, then tighten the screw to secure it.

④ GND (ground) terminal screw

Video signal ground terminal. Insert the shielding mesh of the coaxial cable under the GND terminal plate, then tighten the screw to secure it.

⑤ Cabling tab

When the cables cannot be run behind the ceiling, etc., remove this tab to allow the coaxial cable to go through.

⑥ 24 V AC input terminal (24 V AC, GND)

With this camera use only the 24 V AC power adaptor model No. **VPT-115** available from Sanyo.

■ Power supply connections

Use a 3 wire grounded cable (22 AWG or more), and connect as shown by the illustration.

CAUTION:

- To prevent camera and/or AC adaptor failure, pay close attention polarity when making the connections.
- To prevent fire hazard any UL listed wire rated VW-1, should be used for the 24 V AC cable input terminal.

⑦ Lens cover

This cover will protect the lens from dust and damage. Turn the cover in the direction of the arrow, shown on the illustration, to remove it. To install the cover, align the tabs (A) with the openings, then turn it in the opposite direction.

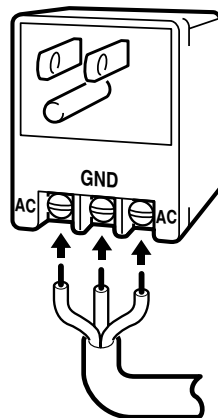

PARTS NAMES AND FUNCTIONS

⑧ Secondary lens cover

⑨ Lens

⑩ Focus ring

To set the focus, loosen the focus ring knob, then turn the ring towards ∞ (infinity) or N (near) as necessary. When the focus is set as desired, tighten the focus ring knob.

⑪ Zoom ring

To adjust the viewing range (zoom), loosen the zoom ring knob, then turn the ring towards T (the range will be smaller and the subject larger) or W (the range will be wider and the subject smaller) as necessary. When the zoom is set as desired, tighten the zoom ring knob.

⑫ GND (ground) pin

For monitor use. (See ⑬)

⑬ MONITOR output pin

When setting up the camera, connect a monitor to this video output pin and to the GND pin using alligator clip cables, then using the image displayed on the monitor, set the surveillance angle and range, the lens focus, etc.

⑭ BLC (backlight compensation) switch

0: Backlight compensation off

1: Backlight compensation on

For backlight compensation, set the BLC switch to 1, then, if necessary, adjust the LEVEL volume control.

⑮ LEVEL volume control

Used when the BLC switch is set to 1. Under normal conditions, it should be turned all the way to the left. When adjusting the backlight compensation, turn it to the right until the desired correction level is obtained.

⑯ L-PHASE (line phase) volume control

Used when the SYNC switch is set to 1. Turn it to adjust the line phase between two or more cameras.

PREPARATIONS AND CONNECTIONS

■ Concerning the coaxial cable

To connect the camera to peripheral devices, use a coaxial cable with BNC plug.

- Cable type RG-6U (5C-2V), 500 m maximum.
- Cable type RG-11U (7C-2V), 600 m maximum.

If the type of peripheral devices connected, the type of cable used and/or the cable length are not as specified, the image and synchronization signals may not be transmitted correctly.

CAUTION:

Use CCTV/Video grade coaxial cable. Due to its construction, an RG-59U cable will not transmit the signal properly when installed through conduits or through the air, and therefore cannot be used.

■ Installing the BNC plug (sold separately)

- 1 Cut the extremity of the coaxial cable (sold separately), as illustrated.
- 2 Insert the cable through the adaptor, then turn the shielding mesh over.
- 3 Loosen the center wire securing screw of the plug, then install the cable in the BNC plug, so that the center wire is threaded through the plug center opening.
Before tightening the center wire securing screw, make sure the center wire comes out through the plug center opening.
- 4 Screw the adaptor onto the plug.

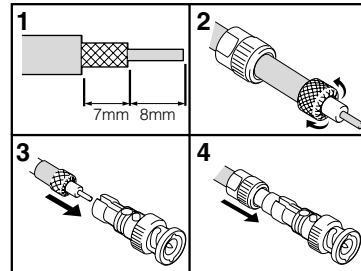

CONNECTIONS AND INSTALLATION

■ Basic connections for monitoring or recording

The peripheral devices (VCR, monitor, etc.) and cables are sold separately.

1 Make the video signal connection between the camera and the monitor or time lapse VCR.

2 Plug the AC adaptor to a wall outlet.

Adjust the picture on the monitor using the Brightness and Contrast controls.

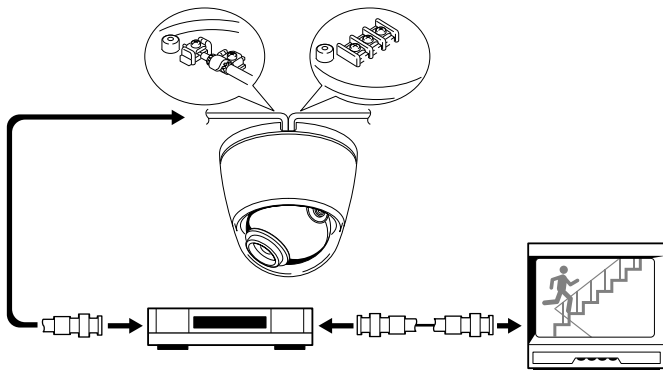

(Example of connection to a monitor)

NOTE: (Fig. 1)

- Make sure the AC adaptor is not connected to the wall outlet before connecting it to the 12 V DC input terminals.
- When making the connections be careful to respect the polarity and not to shortcut the terminals.

■ Multiple cameras connection

You can use multiple cameras by connecting them a camera switcher or a quad unit (sold separately), then conducting the surveillance from one location by splitting the monitor screen to view the image from each camera, or by switching the image from each camera on the monitor screen. For detailed information, please refer to the installed devices instruction manuals.

CONNECTIONS AND INSTALLATION

■ Coaxial cable connection

1 Cut and prepare the extremity of the coaxial cable (sold separately), as illustrated.

2 Attach the coaxial cable to the base.

Loosen the CAMERA (VIDEO) OUT terminal screw (A) and the GND terminal screw (B), then insert the center wire of the coaxial cable in the CAMERA (VIDEO) OUT terminal and make sure the shielding mesh part of the cable is located under the GND terminal plate, then tighten both screws (A and B) to attach the cable.

CAUTION:

If the base is installed on a wall or if for any other reason the cable cannot be run behind the installation surface, break-off the tab (C) with nippers to allow the cable to go through.

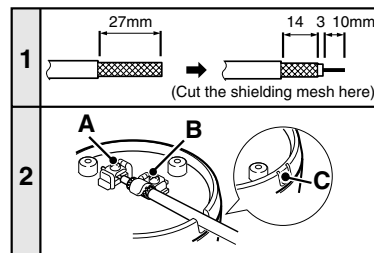

■ Camera installation

1 Install the base on the ceiling, etc., using the four supplied tapping screws (A).

- This camera is not waterproof. It cannot be installed outside.
- When installing the base, make sure to verify that the installation surface will allow full tightening of the screws. Plaster board, etc., may not give a strong enough installation, and it is recommended to use a reinforcement, or other method so that the screws are anchored securely.

CAUTION:

When installing the **base** on a wall, make sure to align it as indicated in **Fig. 1**.

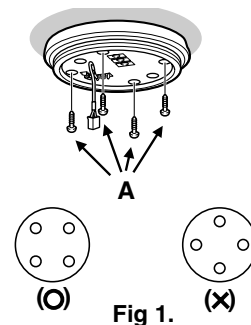

CONNECTIONS AND INSTALLATION

2 Install the camera unit onto the base.

Connect the video signal cable plug (B) and the power supply cable plug (C) from the base to their respective connectors on the camera unit. Then install the camera unit onto the base.

3 Securely tighten the four camera unit fixing screws (D) evenly.

■ Camera removal

1 Loosen the four camera unit fixing screws (A) evenly.

2 Turn the camera unit of about 80°, in the direction of the arrow shown on the illustration.

Turn the camera unit all the way until screw (B) on the base reaches the tab.

3 Remove the camera unit.

To remove the camera unit, carefully apply a slight force until the screw (B) goes over the tab, then carefully remove the camera unit.

CAUTION:

- When removing the camera unit, be careful not to hurt yourself with the camera unit fixing screws.
- When removing the camera unit, be careful as the video signal plug (B) or power supply plug (C) cables are short and may become unplugged.

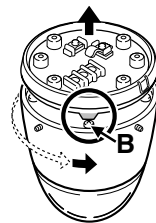
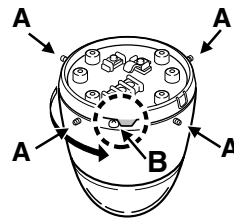
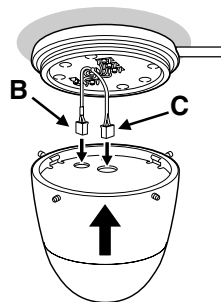

SETTINGS AND ADJUSTMENTS

The digital process may disturb the image for about 5 seconds after the camera is turned on.

■ Factory settings

The camera is shipped from the factory with the following settings. These settings should give adequate results under normal conditions. If the settings need to be modified, please consult the reseller or installer.

- A: BLC (backlight compensation) switch **0 (OFF)**
- B: LEVEL volume control **All the way to the left**
- C: L-PHASE (line phase) volume control **About the center**

■ Backlight compensation setting

When the subject is backlit, set the BLC switch to 1 (ON).

The backlight compensation will measure the light in the center area of the image and the lens iris will be automatically set for optimum image quality. The subject contained in this area will be clear and bright.

- When the sides of the subject background are very bright, and the subject itself is dark.

☞ In this case, the backlight compensation default setting may not give good results. To obtain a better image, set the BLC switch to 1 (ON), then turn the LEVEL volume control to the right until the desired correction level is obtained.

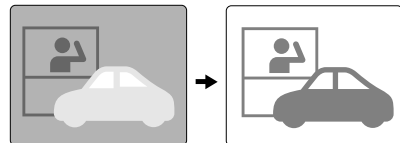
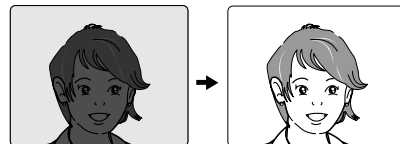
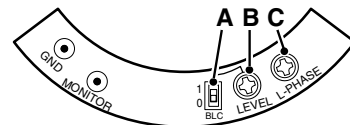

SETTINGS AND ADJUSTMENTS

■ Line phase adjustment

When using a camera switcher to connect two cameras or more to one monitor, there may be a vertical roll of the images when switched, if the phases differ. In such a case, adjust as described below.

Using the camera switcher, switch the display on the monitor from camera 1 to camera 2.

Adjust the **L-PHASE** volume control on camera 2 until the vertical roll of the image stops.

If more than two cameras are used, please repeat this procedure for all the cameras.

NOTE:

If the vertical roll cannot be corrected by adjusting the **L-PHASE** volume on camera 2, try adjusting the **L-PHASE** volume on camera 1. If it still cannot be corrected, please check that the polarity of the power cords of all connected devices is correct.

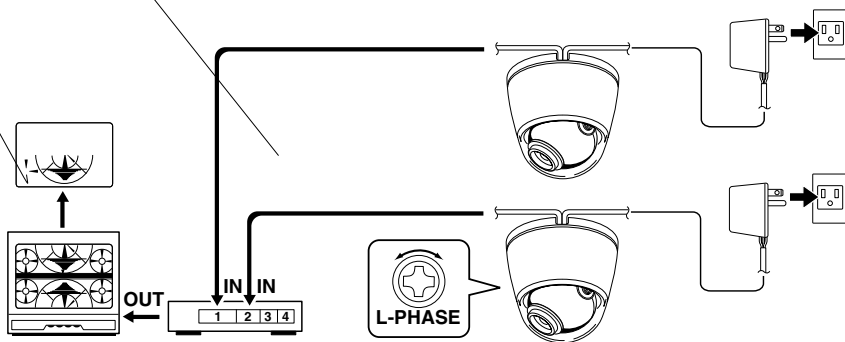

SETTINGS AND ADJUSTMENTS

■ Zoom and focus adjustments

After the camera has been installed, the zoom and focus must be adjusted while viewing on a monitor the transmitted image.

- 1 Remove the lens cover, then press on both sides of the secondary lens cover to remove it.**
- 2 Loosen the zoom ring knob, then turn the ring towards T or W as necessary.**
 - T (zoom in) side
The range will be smaller and the subject larger.
 - W (Zoom out) side
The range will be wider and the subject smaller.
- 3 Loosen the focus ring knob, then turn the ring towards ∞ (infinity) or N (near) as necessary.**

- 4 Repeat steps 2 and 3 until the desired image is obtained.**

When finished, tighten the zoom ring and the focus ring knobs. Then, install the secondary lens cover, making sure it snaps in place and install the lens cover.

NOTE:

While making these settings, be very careful not to scratch or damage the lens.

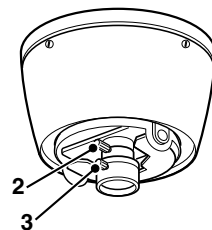
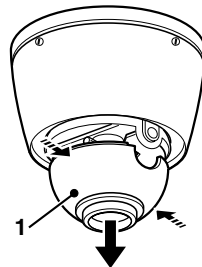

INFRARED (IR LED) ILLUMINATION RANGE

■ Conditions

Room lighting: 0 lux

Reflection rate: 89.9% on subject

Internal lens: at $f=2.6\text{mm}$

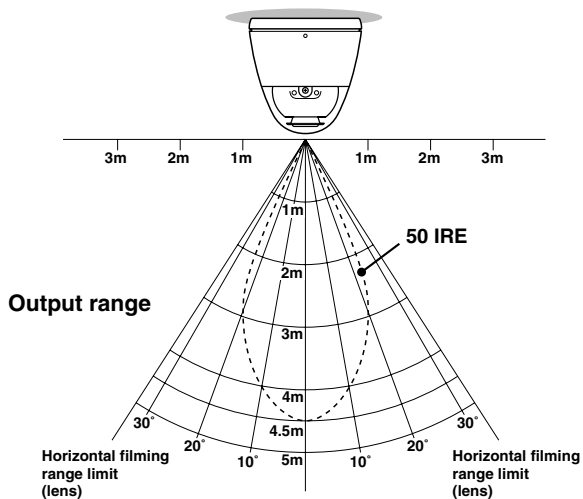

TROUBLESHOOTING

Before taking the camera for repairs, please check below to make sure that the camera is used correctly. If it still does not perform correctly, please consult your dealer or a Sanyo Authorized Service Center.

■ No picture on the monitor screen

- Is the power turned on to all connected devices? Is the voltage correct?
- Are all the signal connecting cables correctly connected?
- Is the lighting sufficient?

■ The picture is not clear

- Is the monitor correctly adjusted?
- Is the lens focus correctly adjusted?
- Are the lens surfaces clean?

If there is dust or finger prints on the lens, the image quality will deteriorate. To clean the lens use a soft cloth or a commercially available lens cleaning set.

SERVICE:

This camera is a precision instruments and, if treated with care, it will provide years of satisfactory performance. However, in the event of a problem, the owner is advised not to attempt to make repairs or open the cabinet. Servicing should always be referred to your dealer or Sanyo Authorized Service Center.

SPECIFICATIONS

TV system	Based on the EIA system
Scanning system	525 TV lines, 60 field/sec., 2:1 interlace
Image device	Interline transfer method, 1/3 inch solid state CCD
Picture elements	537 (H) × 505 (V)
Effective picture elements	510 (H) × 492 (V)
Synchronization system	Internal sync./L-L(Line lock)
Resolution	400 TV lines horizontally, 350 TV lines vertically
Video output signal level	1.0 V _{p-p} /75Ω (screw-on terminal)
S/N ratio	More than 50 dB
Minimum required illumination	0 lux
Backlight compensation	1 (ON)/0 (OFF) manual switching, center area light measuring system
Backlight compensation iris level adjustment	Manual LEVEL volume control
Gain control	Automatic
MONITOR output pin	1.0 V _{p-p} /75Ω, test point pin
Lens	F2.0 ~ 2.7, f=2.6 ~ 5.6 mm, varifocal lens, manual zoom and focus adjustment
Iris system	Mechanical auto iris

Manual adjustment image angle range	Horizontally (pan): ±45°, Vertically (tilt): ±60°, Rotation of the camera unit: ±35°
Operational environmental conditions	Temperature: -10°C ~ +50°C Humidity: less than 90% RH
Storage environmental conditions	Temperature: -20°C ~ +60°C Humidity: less than 70% RH
Power supply	24 V AC
Power consumption	24 V AC/approx. 3.1 W
Weight	Approx. 430 g

Features and specifications are subject to change without prior notice or obligations.

SPECIFICATION

■ DIMENSIONS

